

# Valmet Technical Paper Series

## Roll Cover Development - Calendering

### Executive Summary

Papermaking sets many different challenges for roll covers. Valmet provides a full range of materials and suitable production methods to match all locations on the paper, board or tissue machine, whether rubber, poly, composite or hard coating.

Polymer rolls are used in the elastic roll positions in modern multi-nip calenders. Polymer rolls with tough composite covers offer specific benefits compared to filled paper rolls, including better surface quality, extended grinding intervals, better heat resistance and higher load endurance.

Valmet's unique calendering roll cover lineup includes: CalPanther, for economical endurance; CalJaguar, for reduced maintenance costs and better paper quality, especially coated grades; and the latest entrant, CalLeopard, with the longest regrinding intervals, designed for barring-ridden calenders and the highest loads.

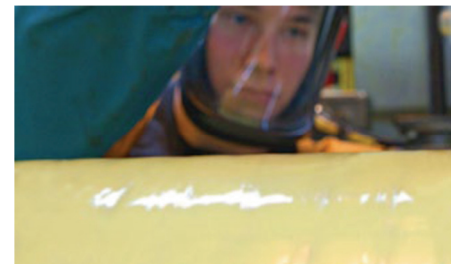
## Trends in roll cover development

Valmet has extensive experience with all modern materials used for papermaking applications. Our recommended solutions are based on proven technology that shares three common denominators: economy, reliability and reduced maintenance. Valmet has also been, and will continue to be, active in bringing out the latest materials technology to improve the competitiveness of its customers.

### Covers for challenging process conditions

The process of papermaking involves many different applications and related challenges for cover materials. Valmet therefore provides a full range of materials. We have developed proprietary cover products and suitable production methods in all primary material groups for use throughout the paper machine, and further development continues.

The major technical parameters to be considered in papermaking applications are moisture level, temperature, mechanical load and the chemical environment. Good solutions for wet conditions may differ from solutions that work in dry conditions. The maximum temperature applied sets further limits on the use of various materials. The wet pressing or calendering load applied, together with the frequency of the loading cycle, is also a basic parameter to consider when comparing different material options. Last, but not least, exposure to chemicals affects roll covers in several different ways.



*Figure 1. Valmet R&D continues to work on roll cover advancements.*

The limits of available cover materials in use can be seen in several different problem areas of papermaking. If the main design parameters are chosen appropriately, problems arise slowly. Valmet is continuously looking for better solutions to address these problems and extend the maintenance intervals of rolls.

One of the most common slow-scale problems is the wear of cover materials. For certain applications, such as wet pressing, coating, calendering and reeling, the best paper quality or best machine runnability can be obtained with soft roll covers. These covers, on the other hand, are prone to wear. Another common slow-scale roll cover problem is vibration. This applies to soft covers used in a variety of nip contacts where the roll covers need to withstand minor inherent structural vibration for as long as possible without amplifying it further.

The slow-scale problems of hard coatings typically relate to surface wear or the accumulation of unwanted material on roll surfaces. This usually degrades the roll profile and thus causes trouble in papermaking. One big challenge in cover development is to find wear-resistant coatings that will not accumulate dirt under papermaking conditions. Corrosion and the loss of coating adhesion to the roll body are also sometimes seen on hard-coated rolls in the longer run.

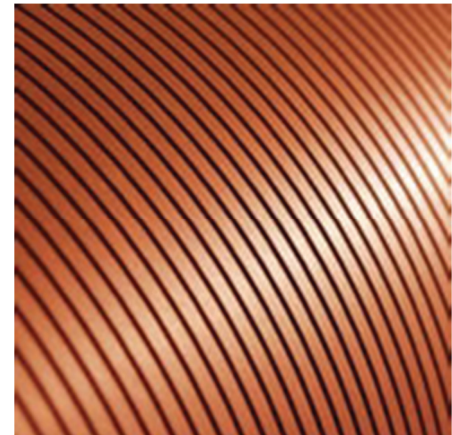
### Rubber covers

Modern rubber covers are based on synthetic rubber compounds. In general, rubber has a high coefficient of heat generation in the loading cycle, which reduces its use in applications where the mechanical load is small or the machine is slow. The most typical applications are different guide rolls for fabrics and the

paper web, size press rolls, mating rolls of blade coaters, and soft reeling cylinders. In some cases rubber covers are also used on primary press rolls and very occasionally on breaker stack rolls. The typical range of hardness for rubber covers ranges from 2 to 200 P&J units and typical thickness from 10 to 50 mm. The cover temperature is ordinarily limited to 90 °C but HNBR tolerates temperatures up to 160 °C or 170 °C.

### Polyurethane covers

Polyurethane covers (**Figure 2**) have mostly been developed for the same applications as rubber covers. The key advantages of polyurethanes are smaller internal heat generation and better wear resistance. These covers need less interior cooling of rolls and are also used in some calendering applications. The thermal curing of polyurethanes does not require as high temperatures as the curing of rubber compounds either. This has an impact on the economics of production and the types of structures that can be covered. On the other hand, the raw materials for polyurethane covers are more expensive than rubber compounds. Polyurethanes also absorb some water, which must be considered in roll maintenance. The typical operating temperature limit is 90 °C in wet conditions and 110 °C to 120 °C in dry conditions.



**Figure 2.** Polyurethane PressFox cover features a new type of bonding structure providing improved durability and safety performance.

### Composite covers

Composite covers (**Figure 3**) are harder than rubber or polyurethane covers. Their typical hardness ranges from 85 ShD to 95 ShD and maximum operating temperature limit up to 100 °C. The coefficient of heat generation is usually very low for composites and internal heat buildup rarely becomes a limiting factor before static strength. The most obvious use for composite covers is therefore found in calendering applications where pressure levels can reach 100 MPa. Indeed, online calendering technology was



**Figure 3.** CalJaguar H composite calender roll cover is developed especially for barring-troubled positions.



**Figure 4.** The novel nanomaterials technology behind ceramic PressJade center roll coatings improves the long-term runnability because of improved stable surface roughness.

made possible by the development of composite covers. Other applications include different guide rolls, mating rolls, spreader rolls, press rolls and reeling cylinders, where composites provide better wear resistance than softer materials. Composite covers are made of matrix material, fillers and reinforcement fibers in different proportions.

### Hard coatings

Novel hard coatings can be subdivided into carbide and ceramic coatings (**Figure 4**). The customary target is to cover a roll with a thin and hard protective layer that will improve its wear

resistance. These types of applications include center rolls, dryer cylinders, thermo rolls and guide rolls. Carbides and ceramics provide hardness levels above 1100 HV. Carbides and ceramics therefore give the best wear resistance and are used in the most demanding applications. In the calendering of glossy paper grades, carbide and ceramic coatings need to be periodically superfinished to keep their surface smooth ( $< 0.2 \text{ mm Ra}$ ). The typical maintenance interval ranges from 6 to 12 months. In other applications the targeted roughness is normally around 1 mm, which can be maintained with proper material selection.

## Materials development and structural design

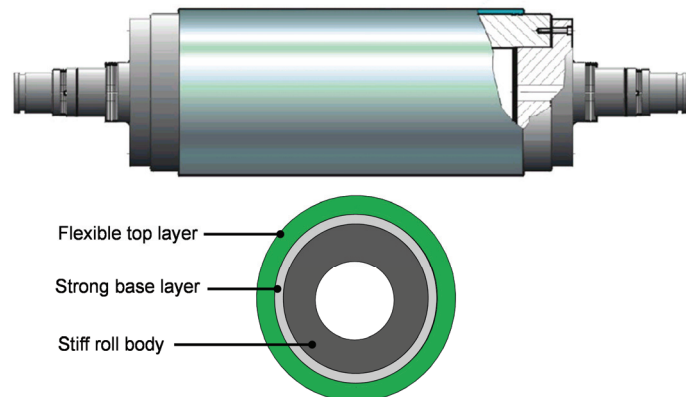
The variety of different paper machine materials is large. Valmet can supply dozens of different cover products for specific uses in the papermaking process. All of these products are based on long and intensive materials development work. It is also not only the choice of materials but the structural design of covers that needs to be optimized. This has been, and will be, a tough but interesting challenge because the requirements of the papermaking process often exceed the demands of any other industry.

## The use of polymer rolls in multi-nip calenders

Polymer rolls are used as elastic rolls in multi-nip calenders (e.g. supercalender). Polymer rolls with tough composite covers (**Figure 5**) offer multiple benefits when compared to traditionally used filled paper rolls, including better surface quality, extended grinding intervals, better heat resistance and higher load endurance. Valmet's polymer rolls can improve the performance of your calender while reducing roll maintenance costs.

The benefits of polymer rolls vs. filled rolls include:

- Fewer roll changes due to wear resistant cover.
- Allows higher nip loads and machine speed for more production.
- Permits higher operational temperature which gives better bulk for paper.
- Smooth runnability is ensured by high manufacturing precision and vibration dampening materials.



**Figure 5. Polymer roll external structure**

## Roll durability and vibration dampening

Valmet polymer rolls are constructed using the best suited materials for each specific application. Good vibration dampening is essential for all roll parts affecting the process. Valmet uses high-quality nodular cast iron EN-GJS-500-7 (ASTM 80-55-06) with good dampening properties in roll parts such as: shell, heads and bearing housings. In some special and rare cases roll weight reduction, limiting of bending or flattening might require a forged steel shell. Polymer rolls can be supplied with or without bearing housings.

Cast iron is an ideal material for the roll shell due to its good vibration dampening properties (**Figure 6**) and low residual stress levels. The relative vibration times with different materials are: gray cast iron = 1 (shortest vibration time due to excellent vibration dampening), nodular cast iron = 1.9 and steel = 3.2.

Valmet has supplied thousands of nipped cast iron rolls to the paper industry worldwide over the past 50 years. This large reference base has established the functionality and durable construction of these rolls.

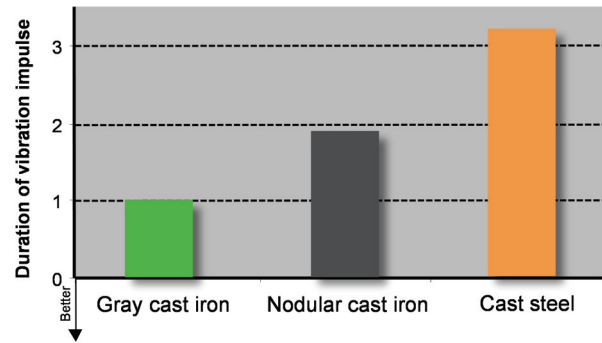
### Performance options

Keeping the roll profile unchanged can require an internal temperature balancing system. For that purpose rolls can either be filled with water-glycol solution or a water circulation system can be used (**Figure 7**).

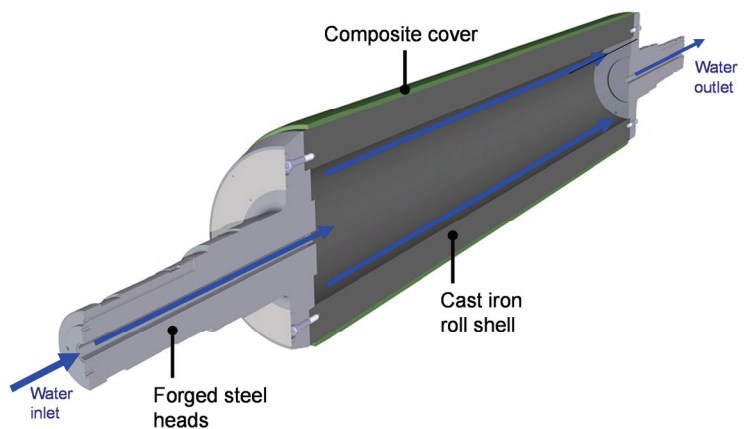
Water circulation is typically arranged by feeding water through the roll via shell center bore. Flowing water evens out local roll shell temperature variations and ensures a more uniform nip load profile. Water circulation also slightly reduces the overall temperature of the roll cover and thereby extends its useful life. Water circulation is most needed in high speed applications (e.g. online calenders).

### Polymer roll applications

Polymer rolls are used as elastic rolls in multi-nip calenders (**Figure 8**). When filled paper rolls are replaced with polymer covered rolls, this replacement typically starts with either the top or bottom roll. The top roll has the highest wear because of paper roughness. The bottom roll is typically under the heaviest loading. It is also the last roll affecting paper quality therefore the roll condition is critical – thus the bottom roll is the most frequently changed.

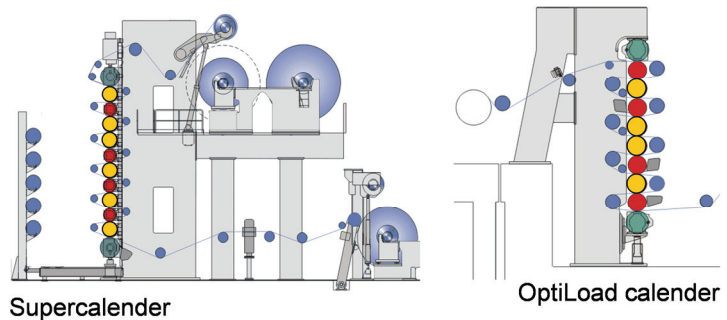


**Figure 6. Better runnability due to vibration dampening properties. Cast iron rolls dampen vibration better than rolls made of steel.**



**Figure 7. Polymer rolls often have water cooling.**

● = Elastic roll positions



**Figure 8. Polymer roll applications in multi-nip calenders**

Wear resistant polymer rolls remarkably reduce the number of required roll changes thus increasing efficient production time (Figure 9). In the supercalender top nip the paper is roughest and because of that this roll is wearing the most. Because of that this is a position where polymer rolls are typically used. In the bottom nip, the high linear load capabilities of polymer rolls come into play.

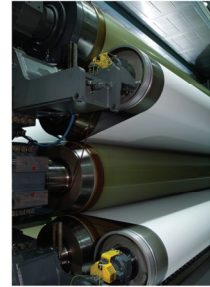
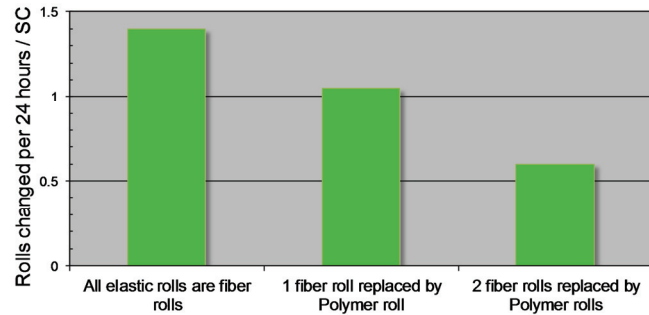


Figure 9. Fewer roll changes are needed when changing from filled to polymer rolls.

When all elastic rolls have been changed into polymer rolls the effect can be as much as 90% less roll changes per produced ton.

### Higher production speeds

A calender with polymer rolls requires less shutdown time for roll grinding changes. This increases efficient calendering time – the calender can handle more paper production (Figure 10). The calender is also not a bottleneck for a papermachine speed increase.

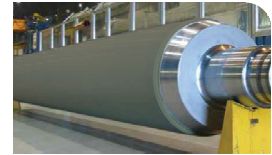
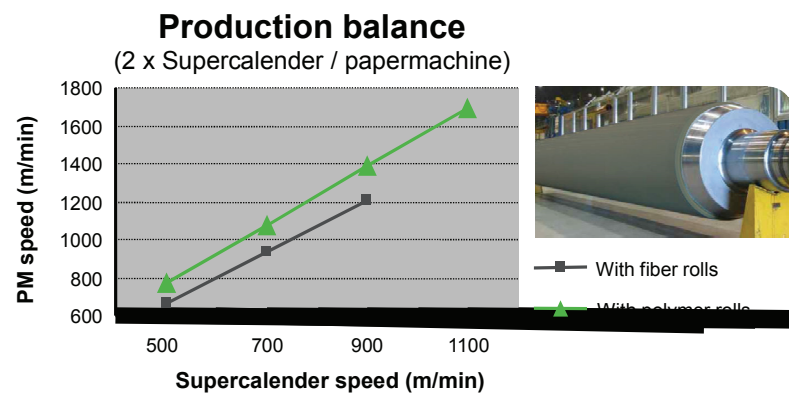


Figure 10. Polymer rolls allow higher production speeds.

### Comparisons of filled and polymer rolls

**Grinding interval:** Filled paper roll gets markings easily during calendering. Depending on the process the required grinding interval varies from a day up to a week. Polymer rolls do not mark as easily. Their grinding interval can be from one to six months.

**Temperature and load resistance:** With filled paper rolls there's a risk that when the roll heats up its surface will 'burn'. Polymer rolls can resist heat better than filled paper rolls. The roll body often has water temperature balancing.

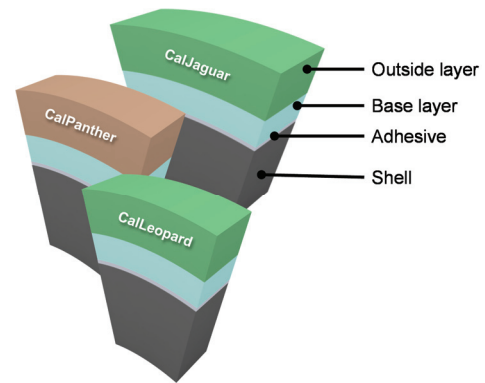
**Good paper quality:** Polymer rolls produce excellent quality paper. However, with SC paper the quality does not improve much over that obtained with filled paper rolls.

**Note:** A polymer roll typically weighs more than a filled roll. Therefore the need for frame modifications must be checked when switching from filled to polymer.

## The advantages of a composite cover structure

The layered structure of composite covers (**Figure 11**) provides a smooth and resilient top layer in contact with the sheet. The top layer is thick for multiple regrinds. The base layer's stiffness is close to that of steel, which increases the cover's durability. The adhesive layer assures good bonding of the cover to the roll body.

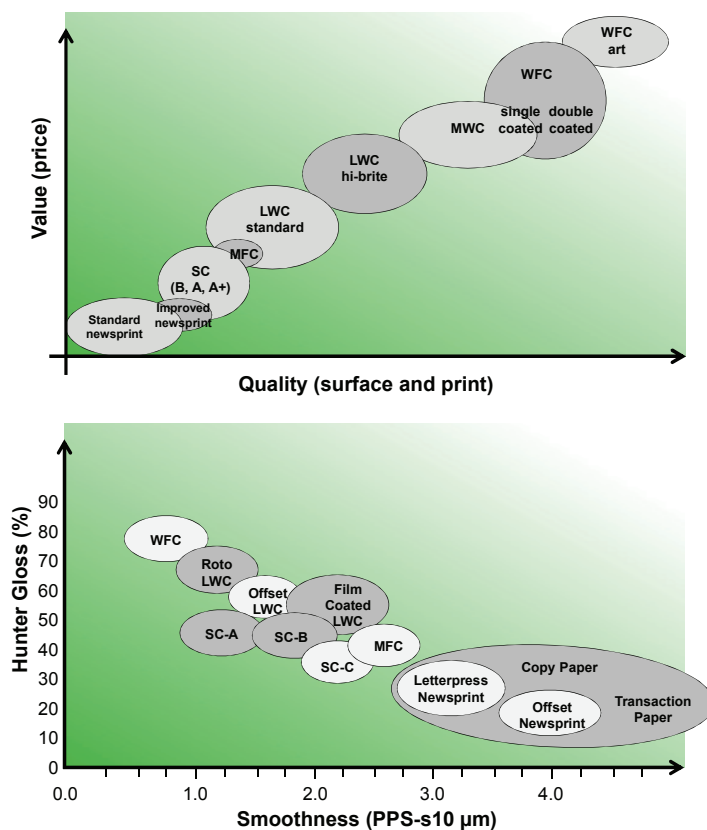
Fiber reinforcement contributes to the durability of composites, giving them high strength and damage resistance. Plus, damaged covers can be band- or patch-repaired. Without fiber reinforcement, covers crack easier and larger pieces can break off in the event of a catastrophic cover failure due to wads, etc. going through the nip. The total thickness is 10.0-15.0 mm, with a top layer of 3.5-8.5 mm and base layer thickness of 6.5 mm.



**Figure 11. Composite cover layered structure**

## Valmet Roll Covers for Calendering

Calendering represents the final chance in papermaking to improve the quality of paper before it is rolled up and calender roll covers for super- or soft-calenders play an important role in this regard. Valmet offers a broad range of roll covers for different calendering processes.



**Figure 12. High value papers are calendered to have excellent surface properties.**

Calendering conditions have become more and more demanding. Ever-growing efficiency requirements put pressure on paper and board makers to increase process temperatures and loads in order to maintain or even increase paper and board quality. Roll covers and their performance must keep pace with these developments. Valmet's composite calender roll covers provide mills a reliable and economical way to meet these challenges.

### Requirements for calender roll covers

Calendering, in general, seeks an increase in paper gloss and a decrease in surface roughness, a decrease in ink absorption, and a high-quality printing result (**Figure 12**). The calendering effect, i.e. what happens to the sheet between two rolls, depends on a large number of variables.

For coated paper, part of calendering is copying the roll surfaces to the paper, so roll surface quality must be excellent, not only on thermo rolls but also on soft-covered rolls. Contact between the sheet and rolls is optimized through nip loading and cover deformation. High temperatures increase the deformability of the roll coating and paper, thus making it easier to get the desired calendering effect. Calender covers must therefore be homogeneous and durable under various loads, speeds and temperatures, while at the same time deformable.

High value papers like WFC have excellent surface properties, such as high gloss and smoothness. These paper properties are determined by the base paper, the coating process, and the calendering process. In calendering, the paper properties are developed as the elastic roll cover presses the paper against the thermo roll, requiring temperature and load, and good contact to the thermo roll. In general, the softer the cover the better it presses onto the paper.

Calendering requires a lot from roll covers due to high loads, speeds and temperatures, as well as doctoring. Moreover, the vibration of heavy, high-speed rotating rolls threatens cover performance. Both the wear from doctoring and cover barring resulting from vibration deteriorate the cover geometry and shorten the operating time of rolls.

In general, a harder cover gives a narrower nip and higher nip pressure, while a softer cover results in a wider nip and lower nip pressure. The effect on paper quality is not very significant, as the differences in stiffness are small, but some paper mills prefer softer covers and others harder covers.

For a singular calender cover quality, the hardness is normally adjusted by amount of (micro-) filler. The total cover also includes the fibers, which influence the final properties of the cover. Generally, the higher the hardness, the more wear resistant the cover is. Also, the higher the hardness, the more brittle the cover behaves, but with fiber-reinforced covers a cover holds together well.

Web breaks cannot be avoided. However, every measure should be taken to reduce their occurrence (good web edges, no wrinkles, no holes in the paper) as well as their impact on the roll covers (web break detection, web cutting, quick nip opening).

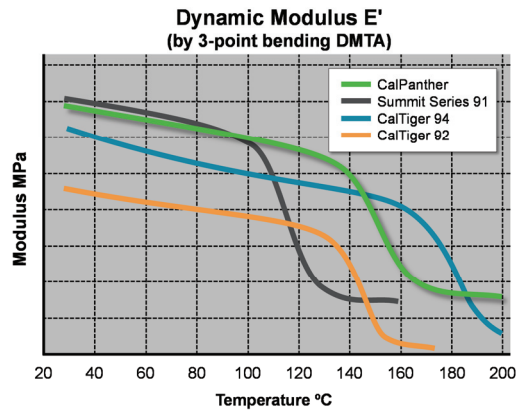
This all presents a challenge, especially for an online calender, where every shutdown is scheduled and random calender soft roll changes are not welcome. The longer the grinding intervals, the higher operational efficiency and flexibility can be.

All Valmet calender roll covers can withstand the operating conditions for which they were designed. However, for severe conditions such as exceptionally high speeds or loads, roll cover condition checks should be performed with Valmet software.

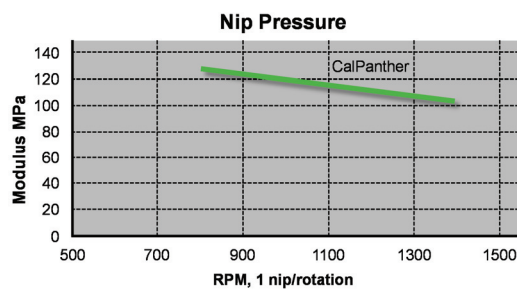
### **CalPanther - tough, yet smooth**

With over 400 CalPanther roll covers delivered since its introduction in 2005, it has proven to be an economical roll cover for enhancing the operation of your calender. It is suitable for online or offline soft calenders, supercalenders and modern multi-nip calenders, regardless of the production line width, speed or make. It can be applied equally well to all paper and board grades. The CalPanther S (designed for soft calenders) and CalPanther H were introduced in 2008 and 2010, respectively.





**Figure 13. CalPanther features high temperature resistance, shown by the dynamic modulus curve.**



**Figure 14. Even at high speeds CalPanther endures high nip pressures.**

Compared to older-generation covers, it features better resistance against all kinds of dents and marking (Figure 15). It is also band repairable. The high wear resistance contributes to long re-grinding intervals, which can extend to over 50 million nip cycles. All in all, CalPanther provides high productivity and low life cycle costs.

One particular LWC line has used CalPanther at all nip locations. This machine's rolls are replaced at regular intervals, and CalPanther has not shown any indications of uneven wear or patterning. The cover has stayed very smooth – around Ra 0.2 to 0.3  $\mu\text{m}$ .

### Valmet CalPanther Benefits

Designed for soft calenders, supercalenders and multi-nip calenders, the CalPanther cover provides the following benefits:

- High temperature resistance
- High load endurance
- Excellent toughness
- Economical in operation
- Well repairable

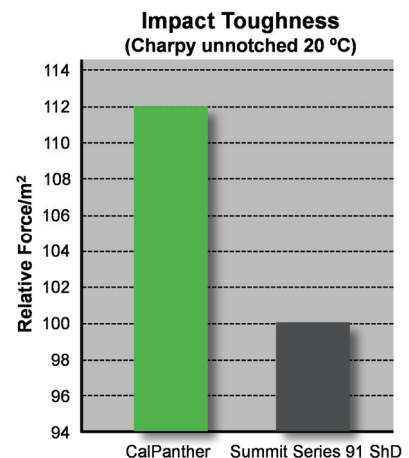
CalPanther features the most common calender cover hardness, 91 ShD. The cover is smooth, Ra 0.4 or 0.6  $\mu\text{m}$ , and smoothens further in use. This makes it especially ideal for calendering paper to produce the highest gloss and smoothness.

### Challenging conditions require a tough cover

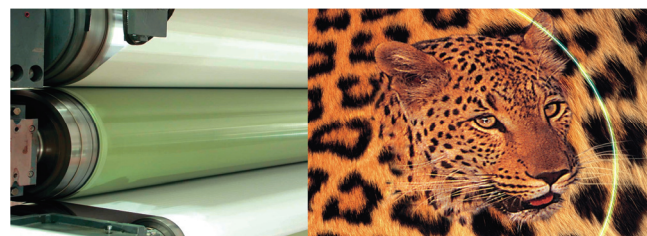
The CalPanther cover tolerates very high temperatures with no difficulties (Figure 13). CalPanther's transient temperature exceeds 293 °F (145 °C), which means excellent thermal durability even in the critical edge areas outside of the web. And even in the toughest calendering conditions when there may be some process irregularities, it is less prone to developing hot spots than earlier-generation covers. For example, in repeated tests, CalPanther was able to endure one third more nip load than similar covers from older generations (Figure 14).

### Long-lasting performance

With CalPanther you can expect a long cover lifetime.



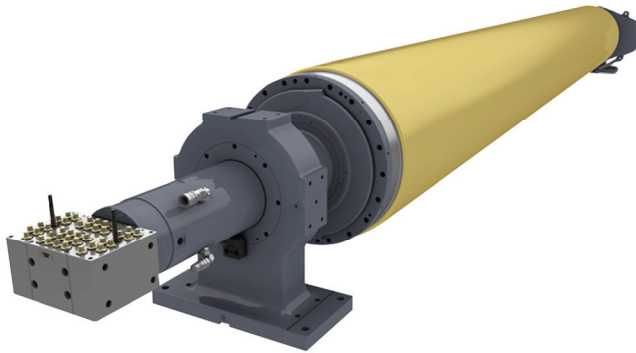
**Figure 15. Compared to other covers, CalPanther's impact toughness is much higher.**



**Figure 16. Valmet CalPanther for high temperature resistance and load endurance.**

## CalJaguar roll cover improves calendering results

CalJaguar's modern manufacturing and materials technology targets simultaneously both paper quality and cover durability. There is a trend to go to harder covers, 92 ShD and more. This results in higher nip



**Figure 17. Valmet's CalJaguar soft cover is developed especially for high-end coated grades.**

pressure with a narrower nip width. CalJaguar on the other hand is a combination of softness and durability, making it a long lasting cover with a good nip contact.

### Based on nanotechnology and new materials

With CalJaguar, Valmet brings to the market a cover directed specifically at coated grades (**Figure 17**). At a hardness of 91 ShD, the cover is less stiff than other covers of the same hardness. But the durability of the cover has not suffered, making this the ideal cover for modern multi-nip calendering conditions. In

fact, the cover's resistance against impact has increased by 40 %, rendering CalJaguar more durable under the abuse of the calendering process, including web break related impact. Moreover, the nanotechnology (**Figure 18**) and new materials employed help to enhance CalJaguar's surface quality. New manufacturing technology makes the cover more homogeneous, which results in more uniform surface properties.

### For better paper quality and economy

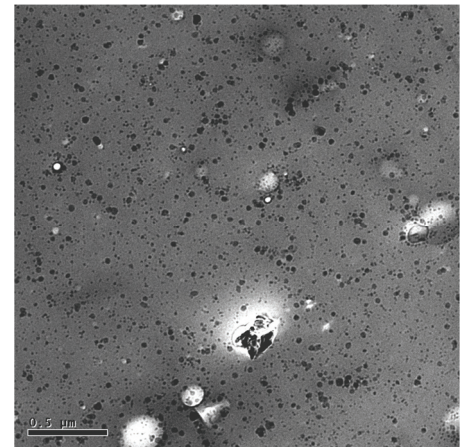
The benefits of CalJaguar for the papermaker are thus twofold. The optimization of the cover for the calendering of coated grades makes it easier to reach or exceed certain quality targets and may allow increases in production output while maintaining the same quality level. The increase in cover durability lengthens cover lifetimes, thereby reducing maintenance costs.

Reference comments about CalJaguar at an LWC mill include "The cover shape holds up well." and "CalJaguar is not much affected by web breaks" as compared to problems the mill has had with other covers.

### CalJaguar H provides exceptional durability

To tackle calendering challenges and extend running times when exposed to vibration, Valmet introduced the CalJaguar H composite roll cover in 2010. It resists barring, the phenomenon in which axial lines are formed on the cover surface. The lines feature micro-scale height differences and affect roll runnability.

Vibration is ever-present in all machinery with rotating components, and particularly pronounced in high-speed online calendering. Thus, barring problems are often seen in online calenders, but they also

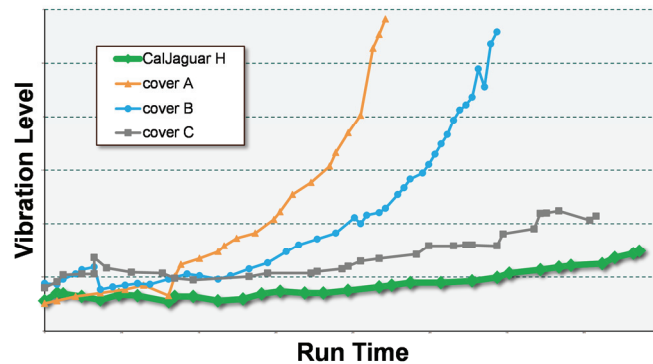


**Figure 18. CalJaguar cover performance is based on the use of a combination of micro- and nano-scale fillers.**

occur in offline calenders. They are most noticeable on the soft-covered rolls that first come into contact with paper. The most critical cover positions are the first intermediate rolls and sometimes also the first load-deflection compensated rolls. Growing deformation increases vibration at all roll positions throughout the calender stack, thereby also detrimentally affecting sheet quality.

**Note:** There are great differences in grinding interval depending on the roll position in the stack.

Roll covers cannot prevent vibration, but barring resistance can be achieved through the use of multiple technologies. The layered construction absorbs vibration (**Figure 19**) and provides durability in operation. The cover surface resists deformation and wear, delaying barring line formation. Enhanced wear resistance results in longer operating times under difficult wear conditions, such as doctoring.



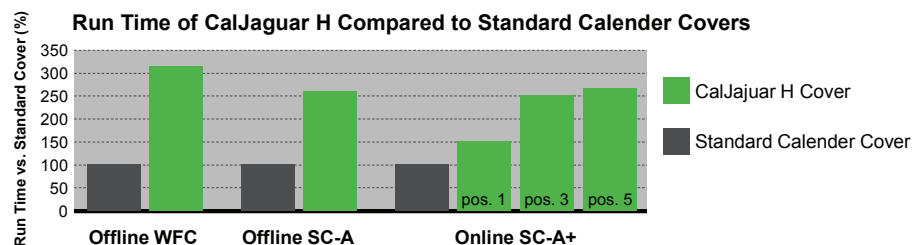
**Figure 19.** CalJaguar H lasts longer than other covers in the same operating conditions, due to reduced vibration.

CalJaguar H has all the typical features of Valmet calender covers, including durability under high load and speed, as well as toughness against impacts. It is especially suitable for modern calendering, for example, with online multi-nip calenders, such as Valmet's OptiLoad and TwinLine.

### Up to 150% longer operation intervals

Positive feedback from mills using CalJaguar H has confirmed its high durability (**Figure 20**). For instance, the operating times of the 1<sup>st</sup> and 2<sup>nd</sup> intermediate roll covers at a WFC mill were significantly shorter than those of the rest of the covers in its offline 10-roll multi-nip calender. Vibration caused by roll flexibility resulted in barred profiling of the cover ends. By replacing a standard cover with CalJaguar H, the operating time was tripled.

A second example comes from a high-speed offline multi-nip calender for SC-A paper. Its production was disturbed by the extremely short running times of the 2<sup>nd</sup> intermediate roll due to vibration. In this



**Figure 20.** CalJaguar H runs over 150% longer than competing covers.

position, the cover is doctoring with a steel blade. The mill installed a CalJaguar H cover, which reached more than 150% higher operating time than the competing covers already during its first run.

A third case involves an OptiConcept machine producing SC paper with an online TwinLine calender. The rolls of this double-stack multi-nip calender initially featured standard covers with short operating intervals. When the mill tried CalJaguar H, it ran almost 50% longer on a Sym roll than the original covers. On the intermediate rolls, the operation intervals improved even more: by over 150%.

With the longer operation time of CalJaguar H, the mill has found a cover that allows more flexibility in operation. Also, the longer lifetime gives more efficiency in operation due to fewer roll changes and less need for grinding. Today, CalJaguar H is the only Valmet cover that the mill uses in vibration-sensitive positions.

### Clean covers with ValEco blades

Doctoring is often needed, and hard steel blades are excellent in keeping cover surfaces clean. But they are harsh on the cover and cause it to wear down locally if blade loading is not controlled properly.

ValEco 4.1 is a carbon-fiber based composite blade that features high wear resistance and minimizes doctoring wear on covers. Thus, the cover keeps its shape, ensuring roll runnability.

With all these solutions, and especially with the CalJaguar H roll cover, mills have reduced their runnability challenges when it comes to calendering. The cover has lived up to expectations, offering longer grinding intervals, higher operational efficiency and flexibility in operation.

### CalLeopard roll cover leaps forward in calendering

CalLeopard, Valmet's newest composite cover for calender rolls (**Figure 21**), provides paper and board makers with extended running times, which means significant cost savings for every ton produced.

Today, calendering is typically an online process; so long uninterrupted running times are extremely important for a calender cover. The list of requirements is long: high wear resistance, superior impact and strength, and excellent barring resistance. The cover must also endure high nip loads at high speeds. The CalLeopard meets these requirements.

CalLeopard's applications include all calenders that are involved in the production of glossy and smooth paper or board grades. It is particularly suitable where high performance is required.

### Long regrinding intervals

The new composite cover presents high wear resistance, allowing for long regrinding intervals with predictable roll change times, less need for roll changes, and fewer regrinds. The latter lowers regrinding costs and extends cover lifetime. As a result, less wear in a cover translates into reduced maintenance costs and trouble-free papermaking.



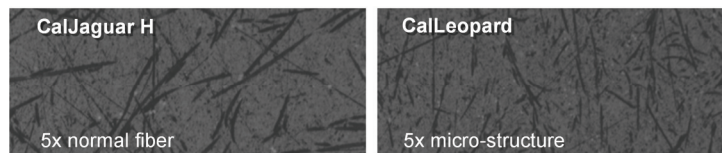
**Figure 21.** The CalLeopard roll cover provides reliable runtime in barring-ridden calenders.

## Excellent reliability

As calender covers are located in the physically most demanding positions in paper and board machines, they need to be durable. High-speed online calenders in particular pose a risk of cover failure, with web breaks causing very severe impacts on the cover. CalLeopard sets a new standard in cover impact durability allowing for very high calender loads at a high nip frequency.

## Extreme barring resistance

Barring is often a problem with online calender rolls. With CalLeopard, material development has now taken a leap forward in barring resistance (**Figure 22**). CalLeopard is the successor to CalJaguar H when it comes to providing long running times under vibration. Increased wear resistance, increased deformation resistance, plus a special base layer delay cover shape deformation and roll vibration. CalLeopard's running time exceeds that of other covers in barring-ridden roll positions, and its barring resistance has been demonstrated on both multi-nip and soft calenders.



**Figure 22.** Microphotographs of the top layer show the finer structure of CalLeopard. This creates a very uniform, strong and durable cover.

## New materials and structure

"Although calender covers cannot remove vibration, the longest running times can be achieved with CalLeopard, allowing easier scheduling of machine shutdowns," says Rob Stapels, Global Technology Manager, Roll Covers.

This nanotechnology cover is the result of intensive development work with new polymer and fiber reinforcement, and with a special focus on a homogenous microstructure.

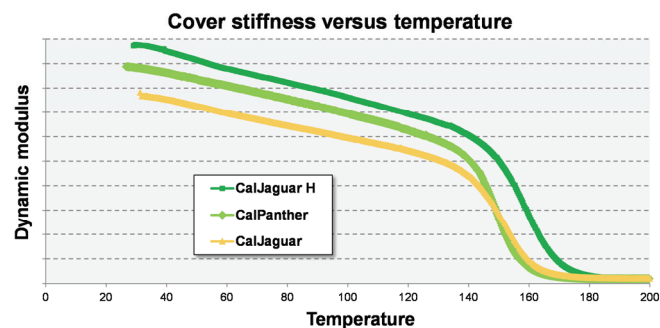
## CalLeopard Benefits

The benefits of the CalLeopard roll cover include:

- Cost savings due to long, reliable runs, especially in barring-ridden calenders.
- Long regrinding intervals, resulting in less need for roll changes.
- Reliability under both high nip load and impact from web breaks.
- Good paper quality.

## Notes on temperature

Valmet composite calender roll covers have a transition temperature of 145 °C, this is the temperature above which the material starts to lose considerable strength (hardness). Note that the temperature measured at the cover surface is always somewhat higher than the temperature underneath the surface, possibly by as much as 20 °C. For continuous use, Valmet



**Figure 23.** Valmet composite calender roll covers have very high temperature durability.

recommends that the cover surface temperatures should not exceed 145 °C for short periods, and not exceed 125-130 °C for continuous use.

When a thermo roll surface temperature, even only occasionally, exceeds 130–150 °C, there should always be paper (or board) between the thermo roll and the polymer cover. Edge areas outside the paper web must be protected either by tapering the polymer edges and/or using edge cooling devices. One of the best methods to protect the cover edges is to run the paper web overly wide.

Cover	Hardness (ShD)	Max Load (pli)	Notes
CalPanther	91	>2500	Standard filler, for general use. Strong cover at normal hardness. Economical with well grindable thickness.
CalPanther S	88	2000	Small amount of very hard filler, mainly for soft calenders where bulk is important. Soft and more durable in load, speed, temperature and wear than other soft covers.
CalPanther H	92	>2500	Large amount of special filler mix, for more wear resistance. Hard, for longer grinding intervals. Also for doctoring positions – ValEco is advised.
CalJaguar	91	>2500	Nano-sized filler particles. Homogenous self-smoothing, for paper grades demanding high quality, especially coated grades
CalJaguar H	92-93	>3100	Nano-sized filler particles. Most deformation and wear resistant, allowing long operation intervals under vibration without effect on paper. More durable than CalJaguar, i.e. for very high load applications. High deformation resistance.
CalLeopard	92	>3100	Nano filler and new fiber material. Stronger, more speed and impact strength. For the highest load applications and barring-intensive calenders. Lowest wear.

**Table 1. Valmet's composite calender roll covers**

## Summary

Valmet's roll cover technology focuses on the key production goals of paper and board makers: a disturbance-free process and high-quality end products. By relying on our roll cover expertise, mills benefit from increased efficiency and productivity, improved paper quality, longer running times, and lower maintenance costs. We offer papermakers an all-inclusive roll cover selection – whatever the paper grade, machine application or machine brand. Our widespread process experience and advanced material technology enable us to provide the right cover for each application.

*This white paper combines technical information obtained from Valmet personnel and published Valmet articles and papers.*

*Valmet provides competitive technologies and services to the pulp, energy and paper industries. Valmet's pulp, paper and power professionals specialize in processes, machinery, equipment, services, paper machine clothing and filter fabrics. Our offering and experience cover the entire process life cycle including new production lines, rebuilds and services.*

*We are committed to moving our customers' performance forward.*